

人工智能开发板 GC-A101

产品手册

Date 2024-04-10

 PLink-AI  HUAWEI  Ascend

品立科技 | 华为APN合作伙伴

Plink-AI | HUAWEI APN Partner

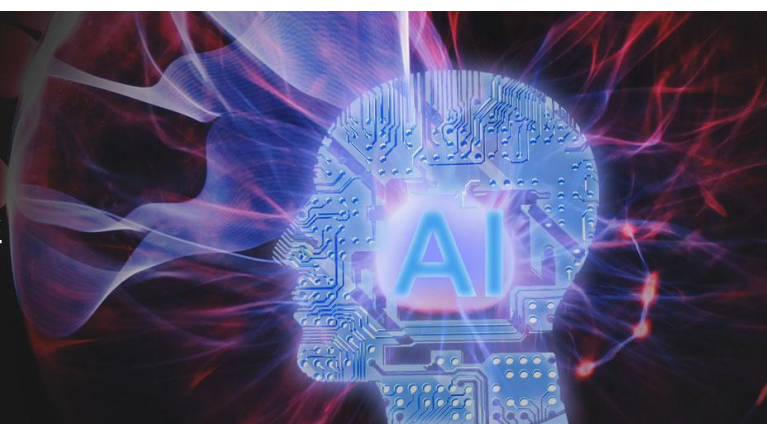

北京品立科技有限责任公司保留一切权利。

非经本公司书面许可，任何单位和个人不得擅自摘抄、复制本文档内容的部分或全部，并不得以任何形式传播。

 **注意**

您购买的产品、服务或特性等应受品立科技商业合同和条款的约束，本文档中描述的全部或部分产品、服务或特性可能不在您的购买或使用范围之内。除非合同另有约定，**本公司对本文档内容不做任何明示或暗示的声明或保证。**

由于产品版本升级或其他原因，本文档内容会不定期进行更新。除非另有约定，本文档仅作为使用指导，本文档中的所有陈述、信息和建议不构成任何明示或暗示的担保。

了解更多产品 请扫码



官网



视频号

北京品立科技有限责任公司

网址：<http://www.plink-ai.com/>

地址：北京市海淀区上地三街金隅嘉华大厦C座1106/1108室

联系电话：+86-010-62962285/400-127-3302

GC-A101产品手册修订记录

修订版	修订日期	修订内容	适用硬件版本
V 1.0	2024-04-10	创建文档	V 1.1

产品硬件修订历史

硬件版本	修订日期	修订内容
V 1.1	2024-04-10	初始版本



电子元件和电路对静电放电很敏感，虽然本公司在设计电路板卡产品时会板卡上的主要接口做防静电保护设计，但很难对所有元件及电路做到防静电安全防护。因此在处理任何电路板组件时，建议遵守防静电安全保护措施。

防静电安全保护措施包括但不限于以下几点：

1. 运输、存储过程中应将板卡放在防静电袋中，直至安装部署时再拿出板卡。
2. 在身体接触板卡之前应将身体内寄存的静电释放掉：佩戴放电接地腕带。
3. 仅在静电放电安全区域内操作电路板卡。
4. 避免在铺有地毯的区域搬移电路板。
5. 通过板边接触来避免直接接触板卡上的电子元件。

目 录 CONTENTS

1 产品概述	5
2 产品说明	6
2.1 接口说明	6
3 模组参数	7
4 正面对外接口	8
4.1 背面对外接口	9
5 GC-A101接口定义描述	10
6 GC-A101指示灯描述	25
7 使用方法	26
7.1 订货信息	26
7.2 特殊说明	26

1 产品概述 Introduction

GC-A101人工智能开发板是一款高性能的AI载板，用于搭载Atlas 200I A2 加速模块，Atlas 200I A2 加速模块集成了昇腾310系列AI处理器，可提供 8 TOPS/20 TOPS 的AI算力，可广泛用于智能监测、教育、机器人等人工智能处理场景。

全板器件均采用宽温工业级型号，主要接口进行了静电安全保护设计，采用了高可靠性的电源应用方案，具有丰富的对外接口。载板带有一个TF卡槽，一个具有多种启动介质的载板可以提供更大的灵活性和兼容性。

- 产品外观展示

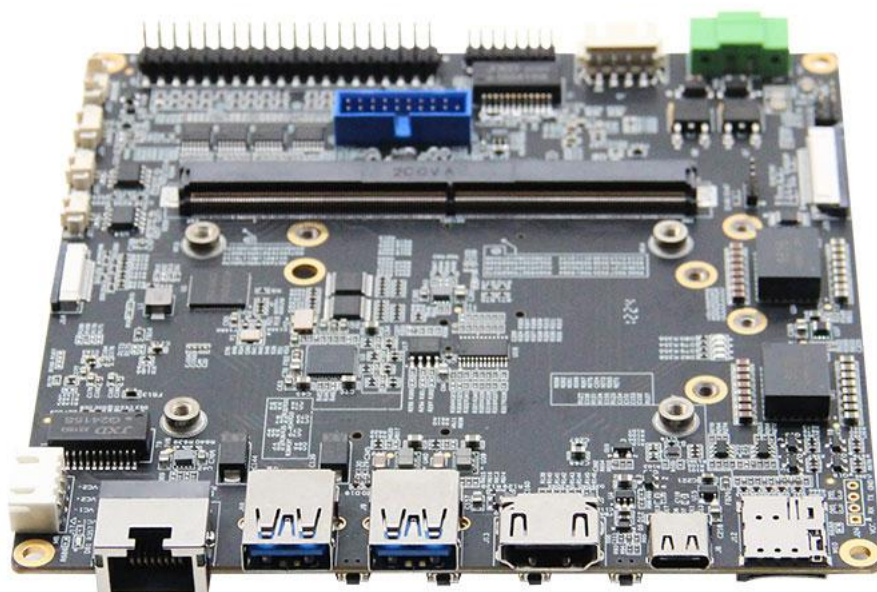

2 产品说明

Carrier board	GC-A101
Module	Ascend Atlas 200I A2 module
Dimensions (L+W+H)	129mm x 135mm x 19mm (Including I/O ports and mounting holes)
Weight	113g
Power supply	DC 19V~36V
OS	openEuler/Ubuntu

Item	Specification
Temperature	-40°C~85°C

I/O Feature

Interface	Quantity	Interface	Quantity
Ethernet Jack	1	USB Type-C	1
Ethetnet Header	1	USB 3.0 Type-A	2
Nano SIM Card Slot	1	USB 3.0 Header (2xUSB3.0)	1
Boot Selection Header	1	HDMI Connector	1
SATA Signal Connector	1	HDMI Type A	1
Power Input	1	FAN Header	1
Micro SD Card Solt	1	AUDIO_IN	1
MIPI DSI	1	AUDIO_OUT	2
Optional POE Header	1	M.2 Key B	1
M.2 Key M	1	M.2 Key E	1
Multi-function Expansion Header	1 (GPIO, I2C, SPI, I2S, UART.....)		

3 模组参数 (Ascend Atlas 200I A2)

	20 TOPS 12GB	20 TOPS 8GB	8 TOPS 4GB
AI Compute Power	20 TOPS INT8 10 TFLOPS FP16		8 TOPS INT8 4 TFLOPS FP16
Memory	12GB 96bit LPDDR4x 4266 Mbps (ECC)	8GB 64bit LPDDR4x 4266 Mbps (ECC)	4GB 64bit LPDDR4x 3200 Mbps (ECC)
Encoding	20x 1080p 30fps(H.264/H.265) 3x 4k 50fps(H.264/H.265)		12x 1080p 30fps (H.264/H.265) 2x 4k 50fps (H.264/H.265)
Decoding	40x 1080p 30fps(H.264/H.265) 4x 4k 75fps(H.264/H.265)		20x 1080p 30fps (H.264/H.265) 2x 4k 75fps (H.264/H.265)
JPEG Encoding	1080p 256fps		1080p 256fps
JPEG Decoding	1080p 512fps		1080p 512fps
Power	25W	24.5W	21W

4 正面对外接口

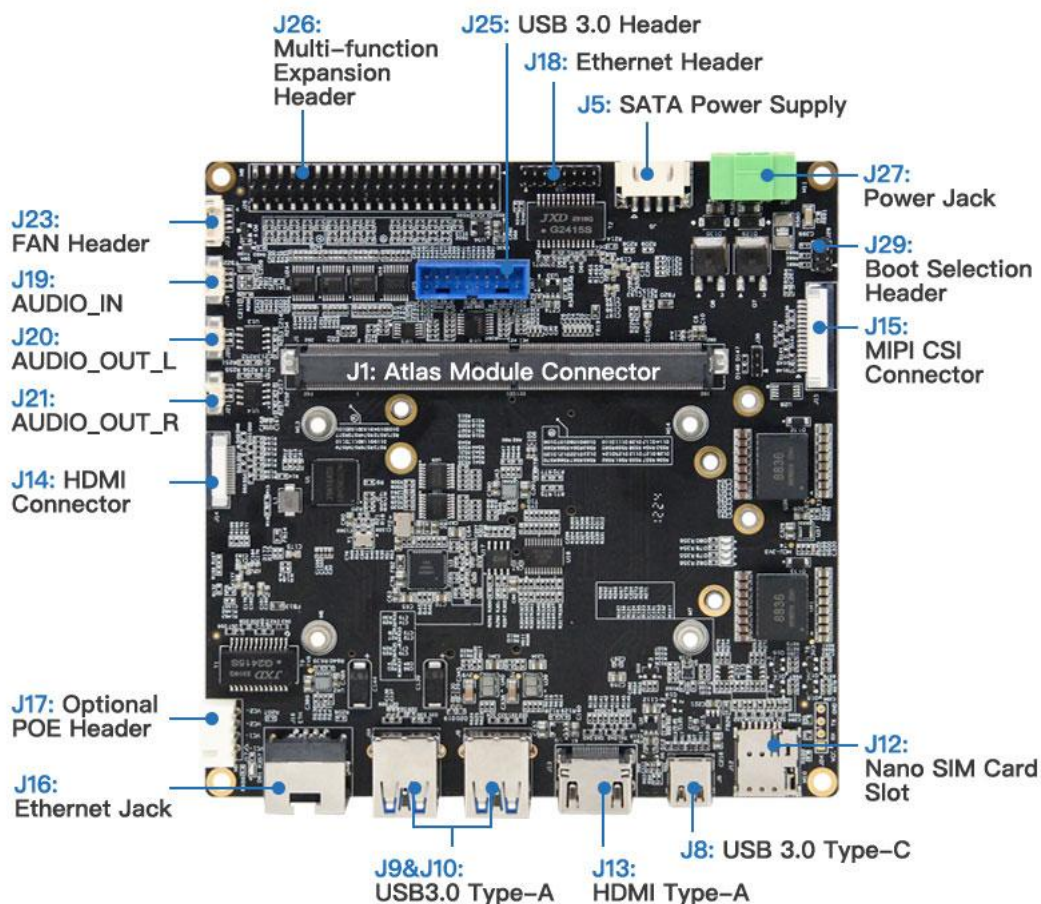

正面功能连接器

指示标识	功能描述	指示标识	功能描述
J1	Atlas Module Connector	J16	Ethernet Jack
J10/J9	USB3.0 Type A	J13	HDMI Type A
J8	USB Type-C	J12	Nano SIM Card Slot
J15	MIPI DSI	J29	Boot Selection Header
J27	Power Input	J5	SATA Power Supply
J18	Ethernet Header	J25	USB3.0 Header(2xUSB3.0)
J23	Fan Header	J19	AUDIO_IN
J20/J21	AUDIO_OUT(L/R)	J14	HDMI Connector
J17	Optional POE Header	J26	Mult-function Expansion Header

背面对外接口

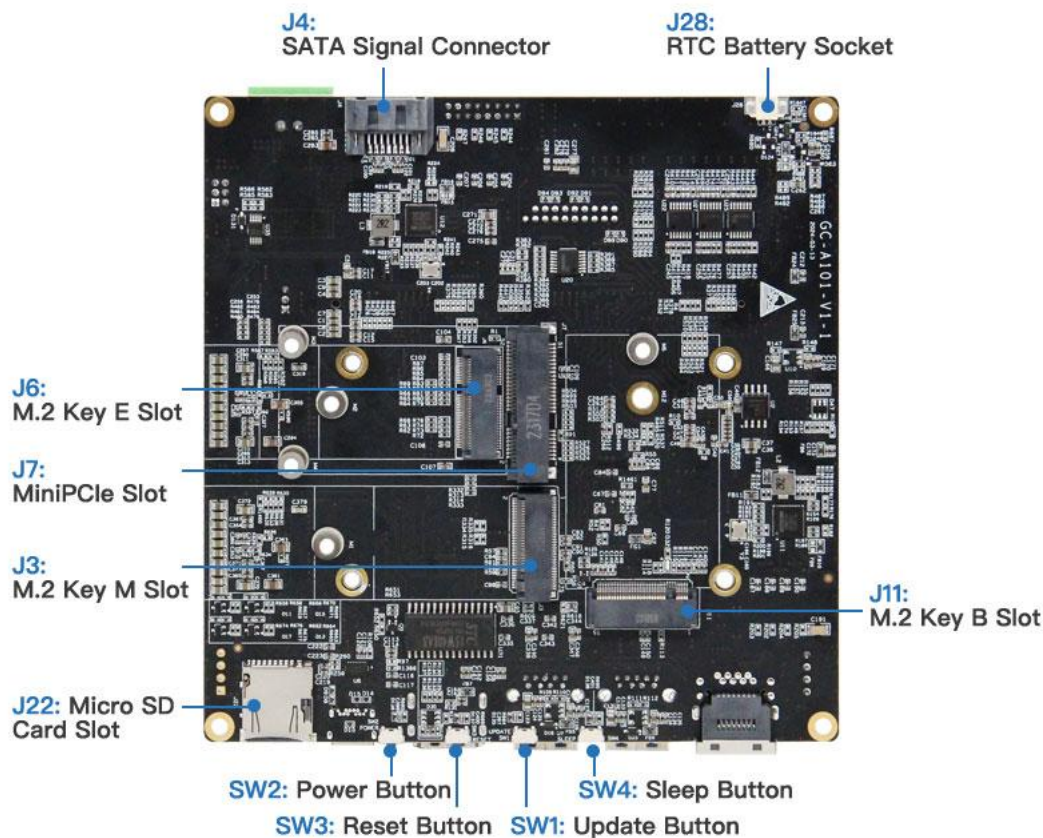

背面功能连接器

指示标识	功能描述	指示标识	功能描述
J4	SATA Signal Connector	J28	RTC Battery Socket
SW4	Sleep Button	SW2	Power Button
SW3	Reset Button	SW1	Update Button
J7	miniPCIe Slot	J6	M.2 Key E Slot
J3	M.2 Key M Slot	J11	M.2 Key B Slot
J22	Micro SD Card Slot		

5 GC-A101接口定义描述

注:所有红色边框圈起来的有三角形符号的是1号引脚

Atlas Module Connector (J1)	
功能	连接Atlas 200I A2 加速模块
标识	J1
类型/型号	ASOB826-S55B-7H
引脚定义	该连接器的引脚定义, 请参阅连接Atlas 200I A2 加速模块数据手册中的引脚定义说明



USB 3.0 Type A (J9/J10)																													
功能	TYPE A 型USB3.0 连接器																												
标识	J9/J10																												
类型/型号	Type-A 型标准 USB 3.0 接口																												
引脚定义	<table border="1"> <thead> <tr> <th>引脚</th> <th>信号</th> <th>引脚</th> <th>定义</th> </tr> </thead> <tbody> <tr> <td>1</td> <td>VBUS</td> <td>2</td> <td>DN</td> </tr> <tr> <td>3</td> <td>DP</td> <td>4</td> <td>GND</td> </tr> <tr> <td>5</td> <td>RX_N</td> <td>6</td> <td>RX_P</td> </tr> <tr> <td>7</td> <td>GND</td> <td>8</td> <td>TX_N</td> </tr> <tr> <td>9</td> <td>TX_P</td> <td>10</td> <td>GND</td> </tr> <tr> <td>11</td> <td>GND</td> <td></td> <td></td> </tr> </tbody> </table>	引脚	信号	引脚	定义	1	VBUS	2	DN	3	DP	4	GND	5	RX_N	6	RX_P	7	GND	8	TX_N	9	TX_P	10	GND	11	GND		
引脚	信号	引脚	定义																										
1	VBUS	2	DN																										
3	DP	4	GND																										
5	RX_N	6	RX_P																										
7	GND	8	TX_N																										
9	TX_P	10	GND																										
11	GND																												

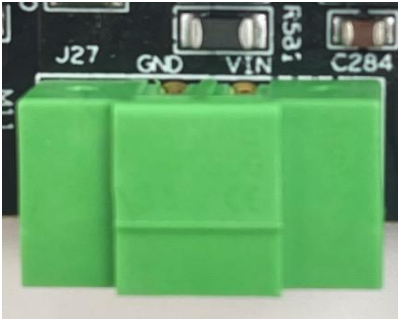

Power Input (J27)				
功能	电源输入端子(母头)			
标识	J27			
类型/型号	XK15EDGRM-3.5MM-2P			
引脚定义	引脚	信号	引脚	定义
	1	GND(-)	2	VIN(+)
DC19~36V				
				

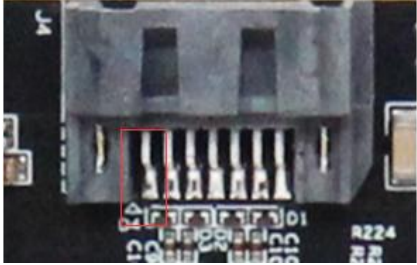
SATA Signal Connector (J4)				
功能	SATA连接器			
标识	J4			
类型/型号	XUTS-0727-0332			
引脚定义	引脚	信号	引脚	定义
	1	GND	2	A+
	3	A-	4	GND
	5	B-	6	B+
	7	GND	8	TAB
	9	TAB1		
				

STAT Power Supply(J5)				
功能	SATA电源支持			
标识	J5			
类型/型号	XH-4AWT			
引脚定义	引脚	信号	引脚	定义
	1	VCC(12V)	2	GND
	3	GND	4	VCC(5V)
				

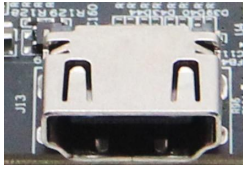
HDMI Type A (J13)																																																			
功能	Type A型HDMI连接器																																																		
标识	J13																																																		
类型/型号	Type-A 标准HDMI 连接器																																																		
引脚定义	<table border="1"> <thead> <tr> <th>引脚</th> <th>信号</th> <th>引脚</th> <th>信号</th> </tr> </thead> <tbody> <tr> <td>1</td> <td>D2+</td> <td>2</td> <td>D2_SHIELD</td> </tr> <tr> <td>3</td> <td>D2-</td> <td>4</td> <td>D1+</td> </tr> <tr> <td>5</td> <td>D1_SHIELD</td> <td>6</td> <td>D1-</td> </tr> <tr> <td>7</td> <td>D0+</td> <td>8</td> <td>D0_SHIELD</td> </tr> <tr> <td>9</td> <td>D0-</td> <td>10</td> <td>CK+</td> </tr> <tr> <td>11</td> <td>CK_SHIELD</td> <td>12</td> <td>CK-</td> </tr> <tr> <td>13</td> <td>CEC</td> <td>14</td> <td>RESERVED</td> </tr> <tr> <td>15</td> <td>SCL</td> <td>16</td> <td>SDA</td> </tr> <tr> <td>17</td> <td>DDC/CEC_GND</td> <td>18</td> <td>+5V</td> </tr> <tr> <td>19</td> <td>HP_DET</td> <td>20</td> <td>SHIELD1</td> </tr> <tr> <td>21</td> <td>SHIELD2</td> <td></td> <td></td> </tr> </tbody> </table>			引脚	信号	引脚	信号	1	D2+	2	D2_SHIELD	3	D2-	4	D1+	5	D1_SHIELD	6	D1-	7	D0+	8	D0_SHIELD	9	D0-	10	CK+	11	CK_SHIELD	12	CK-	13	CEC	14	RESERVED	15	SCL	16	SDA	17	DDC/CEC_GND	18	+5V	19	HP_DET	20	SHIELD1	21	SHIELD2		
引脚	信号	引脚	信号																																																
1	D2+	2	D2_SHIELD																																																
3	D2-	4	D1+																																																
5	D1_SHIELD	6	D1-																																																
7	D0+	8	D0_SHIELD																																																
9	D0-	10	CK+																																																
11	CK_SHIELD	12	CK-																																																
13	CEC	14	RESERVED																																																
15	SCL	16	SDA																																																
17	DDC/CEC_GND	18	+5V																																																
19	HP_DET	20	SHIELD1																																																
21	SHIELD2																																																		

AUDIO OUT L (J20) / AUDIO OUT R(J21)											
功能	音频输出										
标识	J20/J21										
类型/型号	A1251WR-S-2P										
引脚定义	<table border="1"> <thead> <tr> <th>引脚</th> <th>信号</th> <th>引脚</th> <th>定义</th> </tr> </thead> <tbody> <tr> <td>1</td> <td>VO1</td> <td>2</td> <td>VO2</td> </tr> </tbody> </table> <p>J20:左声道输出 J21:右声道输出</p> <p>每个声道功放输出功率: 3w@3欧</p>			引脚	信号	引脚	定义	1	VO1	2	VO2
引脚	信号	引脚	定义								
1	VO1	2	VO2								

HDMI Connector (J14)																																																	
功能	HDMI连接器																																																
标识	J14																																																
类型/型号	AFC07-S20FCC-00																																																
引脚定义	<table border="1"> <thead> <tr> <th>引脚</th> <th>信号</th> <th>引脚</th> <th>信号</th> </tr> </thead> <tbody> <tr> <td>1</td> <td>NC</td> <td>2</td> <td>HDMI_TX2_P</td> </tr> <tr> <td>3</td> <td>HDMI_TX2_N</td> <td>4</td> <td>GND</td> </tr> <tr> <td>5</td> <td>HDMI_TX1_P</td> <td>6</td> <td>HDMI_TX1_N</td> </tr> <tr> <td>7</td> <td>GND</td> <td>8</td> <td>HDMI_TX0_P</td> </tr> <tr> <td>9</td> <td>HDMI_TX0_N</td> <td>10</td> <td>GND</td> </tr> <tr> <td>11</td> <td>HDMI_TXC_P</td> <td>12</td> <td>HDMI_TXC_N</td> </tr> <tr> <td>13</td> <td>GND</td> <td>14</td> <td>GND</td> </tr> <tr> <td>15</td> <td>HDMI1_CEC_3V3</td> <td>16</td> <td>HDMI_SCL_5V</td> </tr> <tr> <td>17</td> <td>HDMI_SDA_5V</td> <td>18</td> <td>HDMI1_HOTPLUG_3V3</td> </tr> <tr> <td>19</td> <td>NC</td> <td>21</td> <td>GND</td> </tr> <tr> <td>22</td> <td>GND</td> <td></td> <td></td> </tr> </tbody> </table>	引脚	信号	引脚	信号	1	NC	2	HDMI_TX2_P	3	HDMI_TX2_N	4	GND	5	HDMI_TX1_P	6	HDMI_TX1_N	7	GND	8	HDMI_TX0_P	9	HDMI_TX0_N	10	GND	11	HDMI_TXC_P	12	HDMI_TXC_N	13	GND	14	GND	15	HDMI1_CEC_3V3	16	HDMI_SCL_5V	17	HDMI_SDA_5V	18	HDMI1_HOTPLUG_3V3	19	NC	21	GND	22	GND		
	引脚	信号	引脚	信号																																													
	1	NC	2	HDMI_TX2_P																																													
	3	HDMI_TX2_N	4	GND																																													
	5	HDMI_TX1_P	6	HDMI_TX1_N																																													
	7	GND	8	HDMI_TX0_P																																													
	9	HDMI_TX0_N	10	GND																																													
	11	HDMI_TXC_P	12	HDMI_TXC_N																																													
	13	GND	14	GND																																													
	15	HDMI1_CEC_3V3	16	HDMI_SCL_5V																																													
	17	HDMI_SDA_5V	18	HDMI1_HOTPLUG_3V3																																													
	19	NC	21	GND																																													
	22	GND																																															

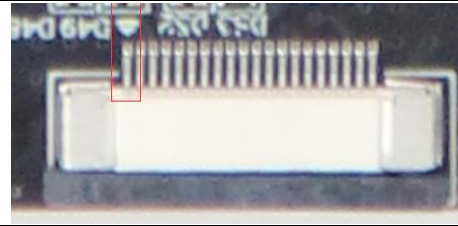

Optional POE Header (J17)													
功能	以太网供电的头部连接器												
标识	J17												
类型/型号	XH-4AW												
引脚定义	<table border="1"> <thead> <tr> <th>引脚</th> <th>信号</th> <th>引脚</th> <th>信号</th> </tr> </thead> <tbody> <tr> <td>1</td> <td>VC1+</td> <td>2</td> <td>VC1-</td> </tr> <tr> <td>3</td> <td>VC2+</td> <td>4</td> <td>VC2-</td> </tr> </tbody> </table>	引脚	信号	引脚	信号	1	VC1+	2	VC1-	3	VC2+	4	VC2-
	引脚	信号	引脚	信号									
	1	VC1+	2	VC1-									
	3	VC2+	4	VC2-									

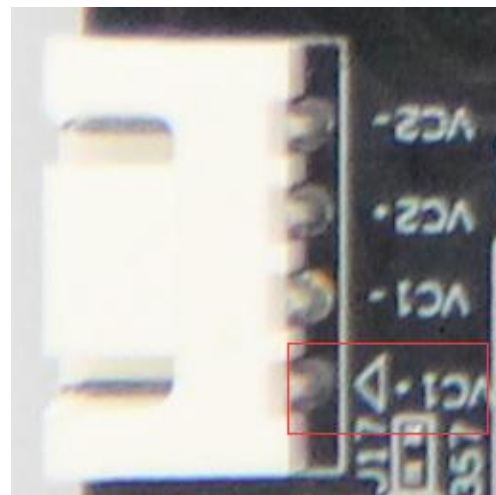

Fan Header (J23)														
功能	调速风扇连接器													
标识	J23													
类型/型号	HCZZ0015-4													
引脚定义	<table border="1"> <thead> <tr> <th>引脚</th> <th>信号</th> <th>引脚</th> <th>信号</th> </tr> </thead> <tbody> <tr> <td>1</td> <td>GND</td> <td>2</td> <td>VCC(12V)</td> </tr> <tr> <td>3</td> <td>TECH0</td> <td>4</td> <td>PWM0</td> </tr> </tbody> </table>		引脚	信号	引脚	信号	1	GND	2	VCC(12V)	3	TECH0	4	PWM0
引脚	信号	引脚	信号											
1	GND	2	VCC(12V)											
3	TECH0	4	PWM0											

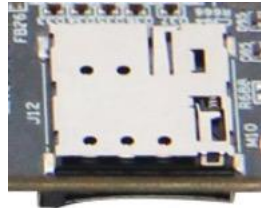
Nano SIM Card Slot (J12)																						
功能	自弹型SIM卡槽																					
标识	J12																					
类型/型号	XDSM-0420-2182B																					
引脚定义	<table border="1"> <thead> <tr> <th>引脚</th> <th>信号</th> <th>引脚</th> <th>信号</th> </tr> </thead> <tbody> <tr> <td>C1</td> <td>USIM1_VDD</td> <td>C2</td> <td>USIM1_RST</td> </tr> <tr> <td>C3</td> <td>USIM1_CLK</td> <td>CD</td> <td>USIM1_DET</td> </tr> <tr> <td>C5</td> <td>GND</td> <td>C6</td> <td>NC</td> </tr> <tr> <td>C7</td> <td>USIM1_DATA</td> <td></td> <td></td> </tr> </tbody> </table>		引脚	信号	引脚	信号	C1	USIM1_VDD	C2	USIM1_RST	C3	USIM1_CLK	CD	USIM1_DET	C5	GND	C6	NC	C7	USIM1_DATA		
引脚	信号	引脚	信号																			
C1	USIM1_VDD	C2	USIM1_RST																			
C3	USIM1_CLK	CD	USIM1_DET																			
C5	GND	C6	NC																			
C7	USIM1_DATA																					

Boot Selection Header (J29)																																								
功能	选择启动方式																																							
标识	J29																																							
类型/型号	HDR200M-2X3																																							
引脚定义	<table border="1"> <thead> <tr> <th>引脚</th> <th>信号</th> <th>引脚</th> <th>信号</th> </tr> </thead> <tbody> <tr> <td>1</td> <td>BOOT_SEL0</td> <td>2</td> <td>GND</td> </tr> <tr> <td>3</td> <td>BOOT_SEL1</td> <td>4</td> <td>GND</td> </tr> <tr> <td>5</td> <td>BOOT_SEL2</td> <td>6</td> <td>GND</td> </tr> </tbody> </table> <p>Atlas 200I A2 模组支持设置如下表格所示的启动介质，用户可通过设置 BOOT_SEL[2:0]的值来选择启动介质，BOOT_SEL[2:0]在Atlas 200I A2 模组上默认上拉，需要与底板配合选择启动方式。</p>			引脚	信号	引脚	信号	1	BOOT_SEL0	2	GND	3	BOOT_SEL1	4	GND	5	BOOT_SEL2	6	GND																					
	引脚	信号	引脚	信号																																				
	1	BOOT_SEL0	2	GND																																				
	3	BOOT_SEL1	4	GND																																				
	5	BOOT_SEL2	6	GND																																				
	<table border="1"> <thead> <tr> <th>BOOT_SEL2</th> <th>BOOT_SEL1</th> <th>BOOT_SEL0</th> <th>启动介质</th> </tr> </thead> <tbody> <tr> <td>0</td> <td>0</td> <td>0</td> <td>SPI NOR Flash</td> </tr> <tr> <td>0</td> <td>0</td> <td>1</td> <td>SPI NOR Flash + UFS</td> </tr> <tr> <td>0</td> <td>1</td> <td>0</td> <td>SPI NOR Flash + PCIe</td> </tr> <tr> <td>1</td> <td>0</td> <td>0</td> <td>SPI NOR Flash + eMMC</td> </tr> <tr> <td>0</td> <td>1</td> <td>1</td> <td>SPI NOR Flash + SSD/SATA</td> </tr> <tr> <td>1</td> <td>0</td> <td>1</td> <td>SPI NOR Flash + SD card</td> </tr> <tr> <td>1</td> <td>1</td> <td>0</td> <td>SPI NOR Flash + USB</td> </tr> <tr> <td>1</td> <td>1</td> <td>1</td> <td>SPI NOR Flash + UART/GE</td> </tr> </tbody> </table>				BOOT_SEL2	BOOT_SEL1	BOOT_SEL0	启动介质	0	0	0	SPI NOR Flash	0	0	1	SPI NOR Flash + UFS	0	1	0	SPI NOR Flash + PCIe	1	0	0	SPI NOR Flash + eMMC	0	1	1	SPI NOR Flash + SSD/SATA	1	0	1	SPI NOR Flash + SD card	1	1	0	SPI NOR Flash + USB	1	1	1	SPI NOR Flash + UART/GE
	BOOT_SEL2	BOOT_SEL1	BOOT_SEL0	启动介质																																				
	0	0	0	SPI NOR Flash																																				
	0	0	1	SPI NOR Flash + UFS																																				
	0	1	0	SPI NOR Flash + PCIe																																				
1	0	0	SPI NOR Flash + eMMC																																					
0	1	1	SPI NOR Flash + SSD/SATA																																					
1	0	1	SPI NOR Flash + SD card																																					
1	1	0	SPI NOR Flash + USB																																					
1	1	1	SPI NOR Flash + UART/GE																																					

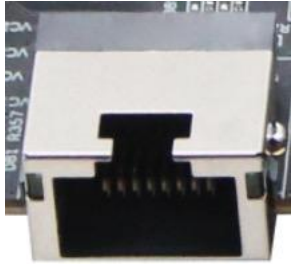
Ethernet Jack (J16)				
功能	RJ45连接器			
标识	J16			
类型/型号	RJ010-A21-F00-106A			
引脚定义	引脚	信号	引脚	信号
	1	MX1+	2	MX1-
	3	MX2+	4	MX3+
	5	MX3-	6	MX2-
	7	MX4+	8	MX4-
				

Ethernet Header (J18)				
功能	千兆网 2.0mm间距插针			
标识	J18			
类型/型号	HDR200M-2X8			
引脚定义	引脚	信号	引脚	信号
	1	GND	2	VCC_3V3
	3	VCC_3V3	4	VCC_3V3
	5	RGMII1_LED0_3V3	6	RGMII1_LED2_3V3
	7	NC	8	NC
	9	ETH1_N_0	10	ETH1_P_0
	11	ETH1_N_1	12	ETH1_P_1
	13	ETH1_N_2	14	ETH1_P_2
	15	ETH1_N_3	16	ETH1_P_3

M.2 Key M Slot (J3)

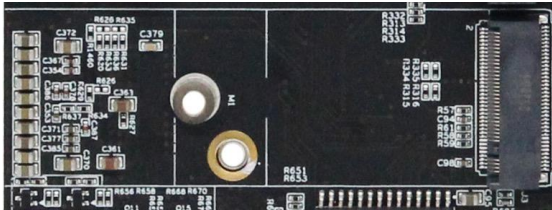
功能	M.2 Key M 槽位							
标识	J3							
类型/型号	APCI0107-P001A, 2242							
引脚定义	标准M.2 Key M接口							
	引脚	信号	引脚	信号	引脚	信号	引脚	信号
	1	GND	2	3.3V	3	GND	4	3.3V
	5	NC	6	NC	7	NC	8	NC
	9	GND	10	NC	11	NC	12	3.3V
	13	NC	14	3.3V	15	GND	16	3.3V
	17	NC	18	3.3V	19	NC	20	NC
	21	GND	22	NC	23	NC	24	NC
	25	NC	26	NC	27	GND	28	NC
	29	SERDES1_RX_N	30	NC	31	SERDES1_RX_P	32	NC
	33	GND	34	NC	35	SERDES1_TX_N	36	NC
	37	SERDES1_TX_P	38	NC	39	GND	40	NC
	41	SERDES0_RX_N	42	NC	43	SERDES0_RX_P	44	NC
	45	GND	46	NC	47	SERDES0_TX_N	48	NC
	49	SERDES0_TX_P	50	PERST#	51	GND	52	CLKREQ#
	53	SERDES0_CLK_N	54	PEWAKE#	55	SERDES0_CLK_P	56	NC
	57	GND	58	NC	59	NC	60	NC
	61	NC	62	NC	63	NC	64	NC
	65	NC	66	NC	67	NC	68	NC
	69	M2M_TYPE_1 V8	70	3.3V	71	GND	72	3.3V
73	GND	74	3.3V	75	GND	76	NC	
77	NC							

M.2 key B Slot (J11)

功能 M Key M.2槽位

标识 J11

类型/
型号 APCI0105-P001A,3050

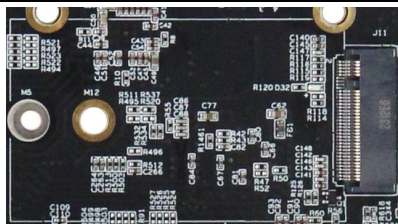

引脚
定义

引脚	信号	引脚	信号	引脚	信号	引脚	信号
1	NC	2	VCC	3	GND	4	VCC
5	GND	6	FULL_CAR D_POWER _OFF#	7	USB20_DP2	8	W_DISABLE1#
9	USB20_DN2	10	WWAN_LE D#	11	GND	12	NC
13	NC	14	NC	15	NC	16	NC
17	NC	18	NC	19	NC	20	NC
21	NC	22	NC	23	VCC_1V8	24	NC
25	NC	26	W_DISABL E2#	27	GND	28	NC
29	USB30_RX_DN 2	30	USIM1_RS T	31	USB30_RX_D P2	32	USIM1_CLK
33	GND	34	USIM1_DA TA	35	USB30_TX_D N2	36	USIM1_VDD
37	USB30_TX_DP 2	38	NC	39	GND	40	NC
41	NC	42	NC	43	NC	44	NC
45	GND	46	NC	47	NC	48	NC
49	NC	50	NC	51	GND	52	NC
53	NC	54	NC	55	NC	56	NC
57	GND	58	NC	59	NC	60	NC
61	NC	62	NC	63	NC	64	NC
65	NC	66	USIM1_DE T	67	RESET#	68	NC
69	NC	70	VCC	71	GND	72	VCC
73	GND	74	VCC	75	NC	76	GND
77	GND						

miniPCle Slot (J7)																																																																																																													
功能	miniPCle 连接器																																																																																																												
标识	J7																																																																																																												
类型/型号	PCIE-52P80H																																																																																																												
引脚定义	<table border="1"> <thead> <tr> <th>引脚</th> <th>信号</th> <th>引脚</th> <th>信号</th> </tr> </thead> <tbody> <tr> <td>1</td> <td>VCC_3V3</td> <td>2</td> <td>3.3Vaux</td> </tr> <tr> <td>3</td> <td>NC</td> <td>4</td> <td>GND</td> </tr> <tr> <td>5</td> <td>NC</td> <td>6</td> <td>+1.5V</td> </tr> <tr> <td>7</td> <td>VCC_3V3</td> <td>8</td> <td>NC</td> </tr> <tr> <td>9</td> <td>GND</td> <td>10</td> <td>NC</td> </tr> <tr> <td>11</td> <td>SERDES6_CLK_N</td> <td>12</td> <td>NC</td> </tr> <tr> <td>13</td> <td>SERDES6_CLK_P</td> <td>14</td> <td>NC</td> </tr> <tr> <td>15</td> <td>GND</td> <td>16</td> <td>NC</td> </tr> <tr> <td>17</td> <td>NC</td> <td>18</td> <td>GND</td> </tr> <tr> <td>19</td> <td>NC</td> <td>20</td> <td>NC</td> </tr> <tr> <td>21</td> <td>GND</td> <td>22</td> <td>MPCIE_PERST_N_3V3</td> </tr> <tr> <td>23</td> <td>SERDES6_RX_N</td> <td>24</td> <td>+3.3Vaux</td> </tr> <tr> <td>25</td> <td>SERDES6_RX_P</td> <td>26</td> <td>GND</td> </tr> <tr> <td>27</td> <td>GND</td> <td>28</td> <td>+1.5V</td> </tr> <tr> <td>29</td> <td>GND</td> <td>30</td> <td>NC</td> </tr> <tr> <td>31</td> <td>SERDES6_TX_N</td> <td>32</td> <td>NC</td> </tr> <tr> <td>33</td> <td>SERDES6_TX_P</td> <td>34</td> <td>GND</td> </tr> <tr> <td>35</td> <td>GND</td> <td>36</td> <td>NC</td> </tr> <tr> <td>37</td> <td>GND</td> <td>38</td> <td>NC</td> </tr> <tr> <td>39</td> <td>+3.3Vaux</td> <td>40</td> <td>GND</td> </tr> <tr> <td>41</td> <td>+3.3Vaux</td> <td>42</td> <td>NC</td> </tr> <tr> <td>43</td> <td>GND</td> <td>44</td> <td>NC</td> </tr> <tr> <td>45</td> <td>NC</td> <td>46</td> <td>NC</td> </tr> <tr> <td>47</td> <td>NC</td> <td>48</td> <td>+1.5V</td> </tr> <tr> <td>49</td> <td>NC</td> <td>50</td> <td>GND</td> </tr> <tr> <td>51</td> <td>NC</td> <td>52</td> <td>+3.3Vaux</td> </tr> </tbody> </table>	引脚	信号	引脚	信号	1	VCC_3V3	2	3.3Vaux	3	NC	4	GND	5	NC	6	+1.5V	7	VCC_3V3	8	NC	9	GND	10	NC	11	SERDES6_CLK_N	12	NC	13	SERDES6_CLK_P	14	NC	15	GND	16	NC	17	NC	18	GND	19	NC	20	NC	21	GND	22	MPCIE_PERST_N_3V3	23	SERDES6_RX_N	24	+3.3Vaux	25	SERDES6_RX_P	26	GND	27	GND	28	+1.5V	29	GND	30	NC	31	SERDES6_TX_N	32	NC	33	SERDES6_TX_P	34	GND	35	GND	36	NC	37	GND	38	NC	39	+3.3Vaux	40	GND	41	+3.3Vaux	42	NC	43	GND	44	NC	45	NC	46	NC	47	NC	48	+1.5V	49	NC	50	GND	51	NC	52	+3.3Vaux
	引脚	信号	引脚	信号																																																																																																									
	1	VCC_3V3	2	3.3Vaux																																																																																																									
	3	NC	4	GND																																																																																																									
	5	NC	6	+1.5V																																																																																																									
	7	VCC_3V3	8	NC																																																																																																									
	9	GND	10	NC																																																																																																									
	11	SERDES6_CLK_N	12	NC																																																																																																									
	13	SERDES6_CLK_P	14	NC																																																																																																									
	15	GND	16	NC																																																																																																									
	17	NC	18	GND																																																																																																									
	19	NC	20	NC																																																																																																									
	21	GND	22	MPCIE_PERST_N_3V3																																																																																																									
	23	SERDES6_RX_N	24	+3.3Vaux																																																																																																									
	25	SERDES6_RX_P	26	GND																																																																																																									
	27	GND	28	+1.5V																																																																																																									
	29	GND	30	NC																																																																																																									
	31	SERDES6_TX_N	32	NC																																																																																																									
	33	SERDES6_TX_P	34	GND																																																																																																									
	35	GND	36	NC																																																																																																									
	37	GND	38	NC																																																																																																									
	39	+3.3Vaux	40	GND																																																																																																									
	41	+3.3Vaux	42	NC																																																																																																									
	43	GND	44	NC																																																																																																									
	45	NC	46	NC																																																																																																									
	47	NC	48	+1.5V																																																																																																									
	49	NC	50	GND																																																																																																									
	51	NC	52	+3.3Vaux																																																																																																									
																																																																																																													

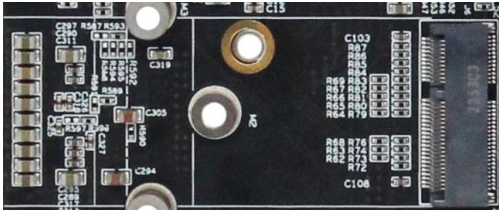
M.2 key E Slot (J6)								
功能	E Key M.2槽位							
标识	J6							
类型/型号	APCI0085-P005A,2230							
引脚定义	引脚	信号	引脚	信号	引脚	信号	引脚	信号
	1	GND	2	3P3V	3	NC	4	3P3V
	5	NC	6	NC	7	GND	8	I2S1_BCLK_1V8
	9	NC	10	I2S1_LRCK_1V8	11	NC	12	I2S1_MISO_1V8
	13	NC	14	I2S1_MOSI_1V8	15	NC	16	NC
	17	NC	18	GND	19	NC	20	3.3V
	21	NC	22	UART3_RX_1V8	23	NC	24	NC
	25	NC	26	NC	27	NC	28	NC
	29	NC	30	NC	31	NC	32	UART3_TX_1V8
	33	GND	34	UART3_CTX_1V8	35	SERDES3_TX_P	36	UART3_RTX_1V8
	37	SERDES3_TX_N	38	NC	39	GND	40	NC
	41	SERDES3_RX_P	42	NC	43	SERDES3_RX_N	44	NC
	45	GND	46	NC	47	SERDES3_CLK_P	48	NC
	49	SERDES3_CLK_N	50	NC	51	GND	52	M2E_PERST_N_3V3
	53	M2E_CLKREQ_N_1V8	54	NC	55	M2E_WAKE_N_3V3	56	NC
	57	GND	58	I2C8_SDA_1V8	59	NC	60	I2C8_SCL_1V8
	61	NC	62	NC	63	GND	64	VCC_1V8
	65	NC	66	NC	67	NC	68	NC
	69	GND	70	NC	71	NC	72	3P3V
	73	NC	74	3P3V	75	GND	76	GND
77	GND							

USB3.0 Header (J25)																																													
功能	USB3.0扩展接口2.0mm排针间距																																												
标识	J25																																												
类型/型号	A37-1BL01-111-A																																												
引脚定义	<table border="1"> <thead> <tr> <th>引脚</th> <th>信号</th> <th>引脚</th> <th>信号</th> </tr> </thead> <tbody> <tr> <td>1</td> <td>VOUT (5V)</td> <td></td> <td></td> </tr> <tr> <td>2</td> <td>USB30_RX_DN3</td> <td>19</td> <td>VOUT(5V)</td> </tr> <tr> <td>3</td> <td>USB30_RX_DP3</td> <td>18</td> <td>USB30_RX_DN4</td> </tr> <tr> <td>4</td> <td>GND</td> <td>17</td> <td>USB30_RX_DP4</td> </tr> <tr> <td>5</td> <td>USB30_TX_DN3</td> <td>16</td> <td>GND</td> </tr> <tr> <td>6</td> <td>USB30_TX_DP3</td> <td>15</td> <td>USB30_TX_DN4</td> </tr> <tr> <td>7</td> <td>GND</td> <td>14</td> <td>USB30_TX_DP4</td> </tr> <tr> <td>8</td> <td>USB20_DN3</td> <td>13</td> <td>GND</td> </tr> <tr> <td>9</td> <td>USB20_DP3</td> <td>12</td> <td>USB20_DN4</td> </tr> <tr> <td>10</td> <td>NC</td> <td>11</td> <td>USB20_DP4</td> </tr> </tbody> </table>	引脚	信号	引脚	信号	1	VOUT (5V)			2	USB30_RX_DN3	19	VOUT(5V)	3	USB30_RX_DP3	18	USB30_RX_DN4	4	GND	17	USB30_RX_DP4	5	USB30_TX_DN3	16	GND	6	USB30_TX_DP3	15	USB30_TX_DN4	7	GND	14	USB30_TX_DP4	8	USB20_DN3	13	GND	9	USB20_DP3	12	USB20_DN4	10	NC	11	USB20_DP4
引脚	信号	引脚	信号																																										
1	VOUT (5V)																																												
2	USB30_RX_DN3	19	VOUT(5V)																																										
3	USB30_RX_DP3	18	USB30_RX_DN4																																										
4	GND	17	USB30_RX_DP4																																										
5	USB30_TX_DN3	16	GND																																										
6	USB30_TX_DP3	15	USB30_TX_DN4																																										
7	GND	14	USB30_TX_DP4																																										
8	USB20_DN3	13	GND																																										
9	USB20_DP3	12	USB20_DN4																																										
10	NC	11	USB20_DP4																																										



AUDIO_IN (J19)													
功能	麦克风接口												
标识	J19												
类型/型号	A1251WR-S-3P												
引脚定义	<table border="1"> <thead> <tr> <th>引脚</th> <th>信号</th> <th>引脚</th> <th>信号</th> </tr> </thead> <tbody> <tr> <td>1</td> <td>AUDIO_IN0R</td> <td>2</td> <td>AUDIO_IN0L</td> </tr> <tr> <td>3</td> <td>MICBIAS</td> <td></td> <td></td> </tr> </tbody> </table>	引脚	信号	引脚	信号	1	AUDIO_IN0R	2	AUDIO_IN0L	3	MICBIAS		
引脚	信号	引脚	信号										
1	AUDIO_IN0R	2	AUDIO_IN0L										
3	MICBIAS												

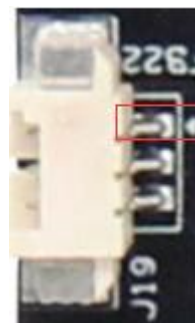

Multi-function Expansion Header (J26)																																																																																					
功能	多功能2.54mm排针间距信号拓展接口																																																																																				
标识	J26																																																																																				
类型/型号	HDR254M-2X20_SMD																																																																																				
引脚定义	引脚 1 位置: 右侧图片红框标识处。																																																																																				
	<table border="1"> <thead> <tr> <th>引脚</th> <th>信号</th> <th>引脚</th> <th>信号</th> </tr> </thead> <tbody> <tr> <td>1</td> <td>3.3V</td> <td>2</td> <td>5V</td> </tr> <tr> <td>3</td> <td>I2C7_SDA_3V3</td> <td>4</td> <td>5V</td> </tr> <tr> <td>5</td> <td>I2C7_SCL_3V3</td> <td>6</td> <td>GND</td> </tr> <tr> <td>7</td> <td>I2S0_MCLK_3V3</td> <td>8</td> <td>UART0_TX_3V3</td> </tr> <tr> <td>9</td> <td>GND</td> <td>10</td> <td>UART0_RX_3V3</td> </tr> <tr> <td>11</td> <td>UART2_RX</td> <td>12</td> <td>I2S0_BCLK_3V3</td> </tr> <tr> <td>13</td> <td>GPIO27_3V3</td> <td>14</td> <td>GND</td> </tr> <tr> <td>15</td> <td>UART1_TX</td> <td>16</td> <td>UART1_RX</td> </tr> <tr> <td>17</td> <td>3.3V</td> <td>18</td> <td>GPIO24_3V3</td> </tr> <tr> <td>19</td> <td>SPI0_MOSI_3V3</td> <td>20</td> <td>GND</td> </tr> <tr> <td>21</td> <td>SPI0_MISO_3V3</td> <td>22</td> <td>GPIO25_3V3</td> </tr> <tr> <td>23</td> <td>SPI0_CLK_3V3</td> <td>24</td> <td>SPI0_CS0_N_3V3</td> </tr> <tr> <td>25</td> <td>GND</td> <td>26</td> <td>UART2_RTX_3V3</td> </tr> <tr> <td>27</td> <td>I2C6_SDA_3V3</td> <td>28</td> <td>I2C6_SCL_3V3</td> </tr> <tr> <td>29</td> <td>I2S1_MCLK_3V3</td> <td>30</td> <td>GND</td> </tr> <tr> <td>31</td> <td>UART2_CTX_3V3</td> <td>32</td> <td>PWM1_3V3</td> </tr> <tr> <td>33</td> <td>GPIO13_3V3</td> <td>34</td> <td>GND</td> </tr> <tr> <td>35</td> <td>I2S0_LRCK_3V3</td> <td>36</td> <td>UART2_TX</td> </tr> <tr> <td>37</td> <td>GPIO26_3V3</td> <td>38</td> <td>I2S0_MISO_3V3</td> </tr> <tr> <td>39</td> <td>GND</td> <td>40</td> <td>I2S0_MOSI_3V3</td> </tr> </tbody> </table>	引脚	信号	引脚	信号	1	3.3V	2	5V	3	I2C7_SDA_3V3	4	5V	5	I2C7_SCL_3V3	6	GND	7	I2S0_MCLK_3V3	8	UART0_TX_3V3	9	GND	10	UART0_RX_3V3	11	UART2_RX	12	I2S0_BCLK_3V3	13	GPIO27_3V3	14	GND	15	UART1_TX	16	UART1_RX	17	3.3V	18	GPIO24_3V3	19	SPI0_MOSI_3V3	20	GND	21	SPI0_MISO_3V3	22	GPIO25_3V3	23	SPI0_CLK_3V3	24	SPI0_CS0_N_3V3	25	GND	26	UART2_RTX_3V3	27	I2C6_SDA_3V3	28	I2C6_SCL_3V3	29	I2S1_MCLK_3V3	30	GND	31	UART2_CTX_3V3	32	PWM1_3V3	33	GPIO13_3V3	34	GND	35	I2S0_LRCK_3V3	36	UART2_TX	37	GPIO26_3V3	38	I2S0_MISO_3V3	39	GND	40	I2S0_MOSI_3V3
	引脚	信号	引脚	信号																																																																																	
	1	3.3V	2	5V																																																																																	
	3	I2C7_SDA_3V3	4	5V																																																																																	
	5	I2C7_SCL_3V3	6	GND																																																																																	
	7	I2S0_MCLK_3V3	8	UART0_TX_3V3																																																																																	
	9	GND	10	UART0_RX_3V3																																																																																	
	11	UART2_RX	12	I2S0_BCLK_3V3																																																																																	
	13	GPIO27_3V3	14	GND																																																																																	
	15	UART1_TX	16	UART1_RX																																																																																	
	17	3.3V	18	GPIO24_3V3																																																																																	
	19	SPI0_MOSI_3V3	20	GND																																																																																	
	21	SPI0_MISO_3V3	22	GPIO25_3V3																																																																																	
	23	SPI0_CLK_3V3	24	SPI0_CS0_N_3V3																																																																																	
	25	GND	26	UART2_RTX_3V3																																																																																	
	27	I2C6_SDA_3V3	28	I2C6_SCL_3V3																																																																																	
	29	I2S1_MCLK_3V3	30	GND																																																																																	
	31	UART2_CTX_3V3	32	PWM1_3V3																																																																																	
	33	GPIO13_3V3	34	GND																																																																																	
	35	I2S0_LRCK_3V3	36	UART2_TX																																																																																	
37	GPIO26_3V3	38	I2S0_MISO_3V3																																																																																		
39	GND	40	I2S0_MOSI_3V3																																																																																		
																																																																																					

RTC Battery Socket (J28)				
功能	实时时钟供电接口			
标识	J28			
类型/型号	A1251WR-S-2P			
引脚定义	引脚	信号	引脚	信号
	1	VCC (3.3V)	2	GND(-)

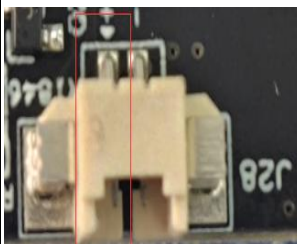

Micro SD Card Slot (J22)				
功能	TF卡槽			
标识	J22			
类型/型号	TF-111			
引脚定义	引脚	信号	引脚	信号
	1	DAT2	2	CD/DAT3
	3	CMD	4	VDD
	5	CLK	6	VSS
	7	DAT0	8	DAT1
	9	SW1	10	SH1
	11	SW2	12	SH2
	13	SH3	14	SH4

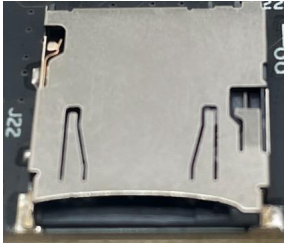

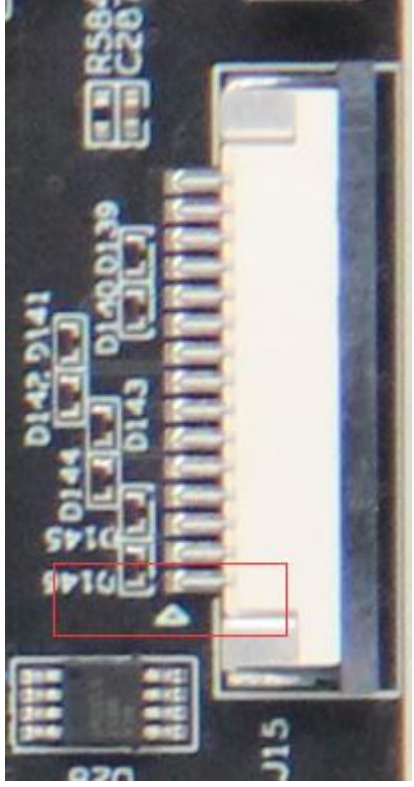
MIPI DSI Connector (J15)																																									
功能	连接显示设备的接口																																								
标识	J15																																								
类型/型号	AFA07-S15FCC-00																																								
引脚定义	<table border="1"> <thead> <tr> <th>引脚</th> <th>信号</th> <th>引脚</th> <th>信号</th> </tr> </thead> <tbody> <tr> <td>1</td> <td>GND</td> <td>2</td> <td>MIPI_DSI_D1_N</td> </tr> <tr> <td>3</td> <td>MIPI_DSI_D1_P</td> <td>4</td> <td>GND</td> </tr> <tr> <td>5</td> <td>MIPI_DSI_CK_N</td> <td>6</td> <td>MIPI_DSI_CK_P</td> </tr> <tr> <td>7</td> <td>GND</td> <td>8</td> <td>MIPI_DSI_D0_N</td> </tr> <tr> <td>9</td> <td>MIPI_DSI_D0_P</td> <td>10</td> <td>GND</td> </tr> <tr> <td>11</td> <td>MIPI_DSI_I2C_SCL_3V3</td> <td>12</td> <td>MIPI_DSI_I2C_SDA_3V3</td> </tr> <tr> <td>13</td> <td>GND</td> <td>14</td> <td>VCC_3V3</td> </tr> <tr> <td>15</td> <td>VCC_3V3</td> <td>16</td> <td>GND</td> </tr> <tr> <td>17</td> <td>GND</td> <td></td> <td></td> </tr> </tbody> </table>	引脚	信号	引脚	信号	1	GND	2	MIPI_DSI_D1_N	3	MIPI_DSI_D1_P	4	GND	5	MIPI_DSI_CK_N	6	MIPI_DSI_CK_P	7	GND	8	MIPI_DSI_D0_N	9	MIPI_DSI_D0_P	10	GND	11	MIPI_DSI_I2C_SCL_3V3	12	MIPI_DSI_I2C_SDA_3V3	13	GND	14	VCC_3V3	15	VCC_3V3	16	GND	17	GND		
引脚	信号	引脚	信号																																						
1	GND	2	MIPI_DSI_D1_N																																						
3	MIPI_DSI_D1_P	4	GND																																						
5	MIPI_DSI_CK_N	6	MIPI_DSI_CK_P																																						
7	GND	8	MIPI_DSI_D0_N																																						
9	MIPI_DSI_D0_P	10	GND																																						
11	MIPI_DSI_I2C_SCL_3V3	12	MIPI_DSI_I2C_SDA_3V3																																						
13	GND	14	VCC_3V3																																						
15	VCC_3V3	16	GND																																						
17	GND																																								
																																									

6 GC-A101指示灯描述

标识 D82



描述: 载板电源输入指示灯

标识 D79



描述: 系统复位指示灯

标识 D78



描述: 过温警告灯 (此灯为红色)

标识 D80



描述: 系统休眠指示灯

标识 D81



描述: 安装模组上电后亮灯, 下电熄灭

7 使用方法 Method of Application

- 确保所有外部系统的电压已关闭。
- 安装必要的外部线缆。
(如: 连接到 HDMI 显示器的显示线, 给系统供电的电源输入线, 链接键盘与鼠标的USB线...)
- 将电源线连接到电源
- 默认系统自动上电。也可以设置为开关启动, 具体方法请咨询本公司销售、技术人员。

订货型号

Model	Description
GC-A101	适配Ascend Atlas 200I A2的工业级接口载板

 GC-A101如果扩展其他功能, 请联系我们。

特别说明

- 初始系统用户: HwHiAiUser, 密码: Mind@123。
- 如果想要提权, 使用su root 进行提权。